

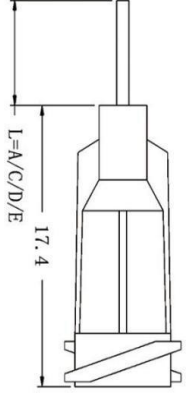



**BALGANESH ENTERPRISES**

Contact person: BALAJI mobile phone/whatsapp: +91 9500748755 (E-mail) : [baalganeshenterprises@gmail.com](mailto:baalganeshenterprises@gmail.com)

products	pictures	blueprint	material	needle length	specification	colors	OD(A)mm	ID(B)mm	packaging
<b>Threaded Plastic Needles</b>			needle tubing: stainless steel pedestal: PP	6.5MM 13MM 25.4MM 38.1MM	14G Special models	olive	2.1	1.61	1000PCS/bag
					14G	olive	1.84	1.55	
					15G	amber	1.82	1.35	
					16G	grey	1.64	1.21	
					17G	saffron	1.49	1.13	
					18G	green	1.27	0.84	
					19G	black	1.03	0.72	
					20G	pink	0.91	0.60	
					21G	violet	0.81	0.51	
					22G	blue	0.71	0.41	
					23G	orange	0.62	0.35	
					24G	burgundy	0.56	0.34	
					25G	red	0.51	0.25	
					26G	light brown	0.45	0.24	
					27G	transparent color	0.41	0.21	
					28G	transparent color	0.35	0.17	
30G	lilac	0.31	0.15						
32G	yellow	0.25	0.10						
34G	violet blue	0.25	0.06						

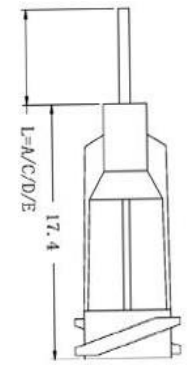
products	pictures	blueprint	material	needle length	specification	colors	OD(A)mm	ID(B)mm	packaging
<b>Plastic elbow needle</b>			needle tubing: stainless steel pedestal: PP 【Needle angle selectable: 45°, 90°】	13MM 25.4MM 38.1MM	14G	olive	1.84	1.55	1000PCS/bag
					15G	amber	1.82	1.35	
					16G	grey	1.64	1.21	
					17G	saffron	1.49	1.13	
					18G	green	1.27	0.85	
					19G	black	1.03	0.72	
					20G	pink	0.91	0.60	
					21G	violet	0.81	0.51	
					22G	blue	0.71	0.41	
					23G	orange	0.62	0.35	
					24G	burgundy	0.56	0.34	
					25G	red	0.51	0.25	
					26G	light brown	0.45	0.24	
					27G	transparent color	0.41	0.21	
					28G		0.35	0.17	
					30G	lilac	0.31	0.15	
32G	yellow	0.25	0.10						



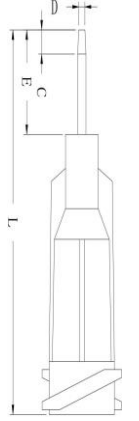

products	pictures	blueprint	material	needle length	specification	colors	OD(A)mm	ID(B)mm	Sharpen length (C)	Needle tip OD(D)
Plastic needles sharpen			needle tubing: PP pedestal: PP	6.5MM 13MM	18G	green	1.28	0.84	1.5	0.93
					19G	black	1.05	0.75	1.0	0.84
					20G	pink	0.91	0.61	1.0	0.7
					21G	violet	0.81	0.51	1.0	0.6
					22G	blue	0.71	0.41	1.0	0.5
					23G	orange	0.63	0.36	1.0	0.45
					24G	burgundy	0.56	0.35	1.0	0.4
					25G	red	0.51	0.27	1.0	0.34
					26G	light brown	0.46	0.25	1.0	0.33
					27G	transparent color	0.41	0.21	1.0	0.29
					28G		0.35	0.18	1.0	0.27
30G	lilac	0.31	0.16	1.0	0.24					

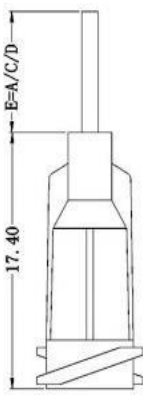

products	pictures	blueprint	material	needle length	specification	colors	OD(A)mm	ID(B)mm	Sharpen length (C)	Needle tip OD(D)
Plastic Needle Grinding Edge			needle tubing: stainless steel304 pedestal: PP	6.5MM 13MM 25MM 38MM	18G	green	1.28	0.84	1.5	0.93
					19G	black	1.05	0.75	1.0	0.84
					20G	pink	0.91	0.61	1.0	0.7
					21G	violet	0.81	0.51	1.0	0.6
					22G	blue	0.71	0.41	1.0	0.5
					23G	orange	0.63	0.36	1.0	0.45
					24G	burgundy	0.56	0.35	1.0	0.4
					25G	red	0.51	0.27	1.0	0.34
					26G	light brown	0.46	0.25	1.0	0.33
					27G	transparent color	0.41	0.21	1.0	0.29
					28G		0.35	0.18	1.0	0.27
30G	lilac	0.31	0.16	1.0	0.24					

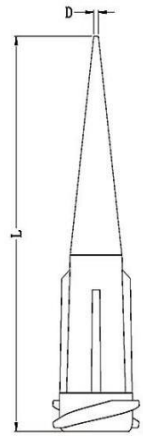
products	pictures	blueprint	material	needle length	specification	colors	OD(A)mm	ID(B)mm	packaging
plastic and steel needle			needle tubing: stainless steel pedestal: PP	6.5MM 13MM 25MM 38MM	14G	light green	2.00	1.70	1000PCS/bag
					15G	darkgreen	1.80	1.50	
					16G	tansparent color	1.60	1.35	
					18G	pink	1.30	1.00	
					19G	cream color	1.05	0.80	
					20G	yellow	0.90	0.65	
					21G	green	0.81	0.55	
					22G	black	0.72	0.45	
					23G	blue	0.63	0.40	
					24G	violet	0.56	0.35	
					25G	orange	0.50	0.30	
					26G	brown	0.45	0.22	
					27G	light grey	0.40	0.18	
28G	light blue	0.35	0.17						
30G	light yellow	0.30	0.13						



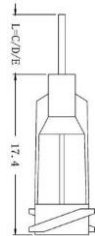

products	pictures	blueprint	material	needle length	specification	colors	ID(B)mm	packaging
TT Needle			needle tubing: stainless steel pedestal: PP		10G	light green	3	1000pcs/bag
					11G	light orange	2.5	
					13G	light blue	2	
					14G	olive	1.56	
					15G	amber	1.36	
					16G	grey	1.21	
					18G	green	0.85	
					20G	pink	0.6	
					21G	violet	0.51	
					22G	blue	0.4	
					23G	orange	0.34	
					25G	red	0.26	
					27G	transparent color	0.21	
					27G	black	0.21	
30G	violet	0.16						

products	pictures	blueprint	material	needle length	specification	colors	OD(A)mm	ID(B)mm	packaging
PP Needle			needle tubing: PP pedestal: PP	6.5MM 13MM 25MM 38MM	14G	olive	1.8	1.30	1000pcs/bag
					15G	amber	1.8	1.10	
					18G	green	1.28	0.90	
					20G	pink	0.9	0.60	
					21G (non-standard)	violet	0.78	0.46	
					22G	blue	0.7	0.40	
					25G	red	0.78	0.32	

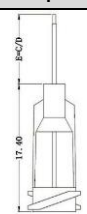
products	pictures	blueprint	material	specification	colors	OD(A)mm	ID(B)mm	length	packaging
all-in-one PP Needle			needle tubing: PP pedestal: PP	14G	white	1.84	1.34	57	50pcs/box
				15G	white	1.82	1.17	57	
				16G	white	1.55	1.20	57	
				18G	red	1.3	0.88	57	
				20G	yellow	0.88	0.60	57	
				22G	black	0.83	0.40	57	
				25G	white	0.8	0.33	57	

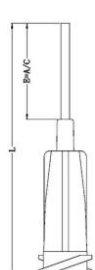
products	pictures	blueprint	material	needle length	specification	colors	OD(A)mm	ID(B)mm	packaging
Teflon Needle			needle tubing: stainless steel pedestal: PP pedestal: PTFE	13MM 25MM	20G	grey	1.64	0.57	1000pcs/bag
					20Gtraceless		1.62	0.63	
					25G	pink	1.27	0.32	
					25Gtraceless		1.27	0.34	
					27G	red	0.91	0.24	
					27Gtraceless		0.91	0.25	

products	pictures	blueprint	material	needle length	specification	colors	OD(A)mm	ID(B)mm	packaging
Aluminum Inlay Needle			needle tubing: stainless steel pedestal: PP	6.5MM 13MM	14G	olive	2.1	1.6	1000pcs/bag
					16G	grey	1.64	1.2	
					18G	dark green	1.28	0.84	
					20G	pink	0.91	0.61	
					22G	blue	0.71	0.41	
					24G	Silver Green	0.56	0.35	
					26G	light yellow	0.46	0.25	
27G	white	0.41	0.21						

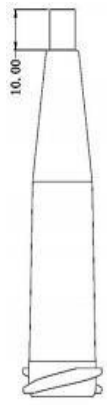
products	pictures	blueprint	material	specification	colors	OD(A)mm	ID(B)mm	brush width	total length
brush needle			paintbrush: aluminum pedestal: nylon	14G	olive	2.10	1.60	3MM 5MM	10MM
				15G	amber	1.84	1.36		
				16G	grey	1.64	1.20		
				17G	saffron	1.48	1.12		
				18G	green	1.28	0.84		
				19G	black	1.05	0.75		
				20G	pink	0.91	0.61		
				21G	violet	0.81	0.51		
				22G	blue	0.71	0.41		
				23G	orange	0.63	0.36		
				24G	burgundy	0.56	0.35		
				25G	red	0.51	0.27		
				26G	light brown	0.46	0.25		
				27G	transparent color	0.41	0.21		

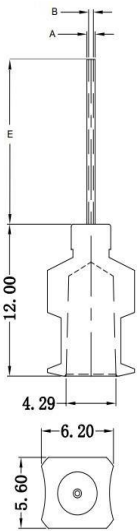
products	pictures	blueprint	material	needle length	specification	OD(A)mm	ID(B)mm	packaging
Metal needle			needle tubing: stainless steel304 pedestal: Brass (Nickel Plated)	3MM	8G	4.00	3.50	12PCS/box
				6.5MM	10G	3.50	3.00	
				13MM	11G	3.00	2.50	
				25MM	12G	2.80	2.30	
				38MM	13G	2.40	1.90	
				50MM	14G	2.10	1.60	
					15G	1.84	1.36	
					16G	1.64	1.20	
					17G	1.48	1.12	
					18G	1.28	0.84	
					19G	1.05	0.75	
					20G	0.90	0.60	
					21G	0.80	0.50	
					22G	0.70	0.40	
					23G	0.63	0.36	
					24G	0.56	0.34	
					25G	0.51	0.26	
					26G	0.46	0.24	
					27G	0.41	0.21	
					28G	0.35	0.18	
	30G	0.31	0.16					
	32G	0.25	0.10					

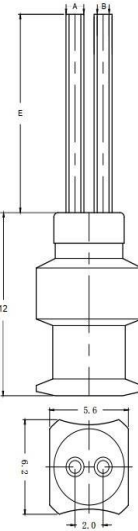
products	pictures	blueprint	material	needle length	specification	OD(A)mm	ID(B)mm	packaging
Double-barreled metal needles			needle tubing: stainless steel304 pedestal: Brass (Nickel Plated)	6.5MM	14G	2.10	1.60	12PCS/box
				13MM	15G	1.84	1.36	
				25MM	16G	1.64	1.20	
				38MM	17G	1.48	1.12	
					18G	1.28	0.84	
					19G	1.05	0.75	
					20G	0.91	0.61	
					21G	0.81	0.51	
					22G	0.71	0.41	
					23G	0.63	0.36	
					24G	0.56	0.35	
					25G	0.51	0.27	
					26G	0.46	0.25	
					27G	0.41	0.21	
	28G	0.35	0.18					
	30G	0.31	0.16					

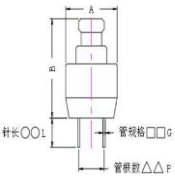
products	pictures	blueprint	material	specification	OD(A)mm	ID(B)mm
Multiple tube dispensing needles			brass	10G	3.50	3.00
				11G	3.00	2.50
				12G	2.80	2.30
				13G	2.40	1.90
				14G	2.10	1.60
				15G	1.84	1.36
				16G	1.64	1.20
				17G	1.48	1.12
				18G	1.28	0.84
				19G	1.05	0.75
				20G	0.91	0.61
				21G	0.81	0.51
				22G	0.71	0.41
				23G	0.63	0.36
				24G	0.56	0.35
				25G	0.51	0.27
				26G	0.46	0.25
27G	0.41	0.21				
28G	0.35	0.18				
30G	0.31	0.16				

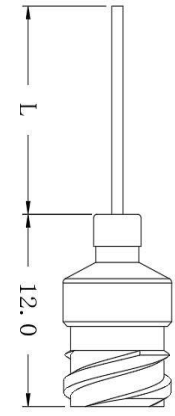
products	pictures	blueprint	material	needle length	specification	OD(A)mm	ID(B)mm	packaging
Double Threaded Needle			needle tubing: stainless steel pedestal: Brass (Nickel Plated)	6.5MM 13MM 25MM 38MM	8G	4.00	3.50	100PCS/box
					10G	3.50	3.00	
					11G	3.00	2.50	
					12G	2.80	2.30	
					13G	2.40	1.90	
					14G	2.10	1.60	
					15G	1.84	1.36	
					16G	1.64	1.20	
					17G	1.48	1.12	
					18G	1.28	0.84	
					19G	1.05	0.75	
					20G	0.91	0.61	
					21G	0.81	0.51	
					22G	0.71	0.41	
					23G	0.63	0.36	
					24G	0.56	0.35	
					25G	0.51	0.27	
26G	0.46	0.25						
27G	0.41	0.21						
28G	0.35	0.18						
30G	0.31	0.16						
32G	0.25	0.10						

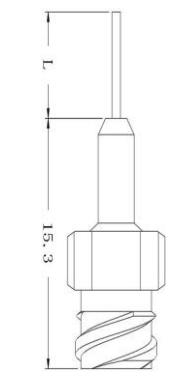
products	pictures	blueprint	material	needle length	specification	OD(A)mm	ID(B)mm	packaging
PUR Needle			needle tubing: stainless steel304 pedestal: Brass (copper natural/nickel plated)	4MM 6.5MM	14G	2.1	1.6	100PCS/box
					15G	1.84	1.36	
					16G	1.64	1.2	
					17G	1.48	1.12	
					18G	1.28	0.84	
					19G	1.05	0.75	
					20G	0.91	0.61	
					21G	0.81	0.51	
					22G	0.71	0.41	
					23G	0.63	0.36	
24G	0.56	0.35						
25G	0.51	0.26						

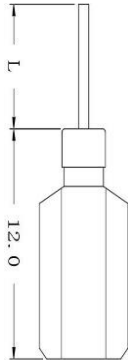
products	pictures	blueprint	material	needle length	specification	OD(A)mm	ID(B)mm	packaging
M5 female thread-hexagonal			needle tubing:stainless steel pedestal:Brass (copper natural color/nickel plated), customizable:stainless steelmaterial	13MM 25MM	8G	4	3.5	100PCS/box
					10G	3.5	3	
					11G	3	2.5	
					12G	2.8	2.3	
					13G	2.4	1.9	
					14G	2.1	1.6	
					15G	1.84	1.36	
					16G	1.64	1.2	
					17G	1.48	1.12	
					18G	1.28	0.84	
					19G	1.05	0.75	
					20G	0.91	0.61	
					21G	0.81	0.51	
22G	0.71	0.41						
23G	0.63	0.36						

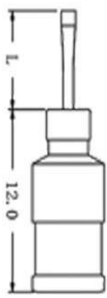
products	pictures	blueprint	material	needle length	specification	OD(A)mm	ID(B)mm	Flat mouth width	Thickness	Flat mouth inner
Metal flat mouth needle			needle tubing: stainless steel304 pedestal: Brass (Nickel Plated)	Length can be customized	8G	4.00	3.50	5.90	1.30	0.6
					10G	3.50	3.00	5.00	1.20	0.6
					11G	3.00	2.50	4.30	1.10	0.6
					12G	2.80	2.30	4.00	1.00	0.6
					13G	2.40	1.90	3.40	0.90	0.6
					14G	2.10	1.60	2.80	1.10	0.6
					15G	1.84	1.36	2.40	1.00	0.6
					16G	1.64	1.20	2.20	0.85	0.6
					17G	1.48	1.12	2.00	0.80	0.6
					18G	1.28	0.84	1.70	0.75	0.6
					19G	1.05	0.75	1.60	0.70	0.6
20G	0.91	0.61	1.15	0.65	0.6					

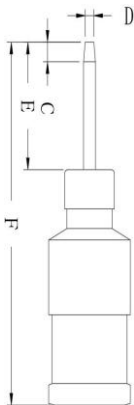
products	pictures	blueprint	material	needle length	specification	OD(A)mm	ID(B)mm	Sharpen length (C)	Needle tip OD(D)	packaging
Metal Needle Sharpening			needle tubing: stainless steel pedestal: Brass (Nickel Plated)	6.5MM 13MM	18G	1.28	0.84	1.5	0.93	12PCS/bo x
					19G	1.05	0.75	1	0.84	
					20G	0.91	0.61	1	0.7	
					21G	0.81	0.51	1	0.6	
					22G	0.71	0.41	1	0.5	
					23G	0.63	0.36	1	0.45	
					24G	0.56	0.35	1	0.44	
					25G	0.51	0.27	1	0.34	
					26G	0.46	0.25	1	0.33	
					27G	0.41	0.21	1	0.29	
					28G	0.35	0.18	1	0.27	
30G	0.31	0.16	1	0.24						

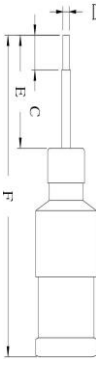

products	pictures	material	needle length	specification	OD(A)mm	ID(B)mm	total length (mm)	packaging
Metal flushing needles		stainless steel		14G	2.1	1.6	4.9	1 stick
				15G	1.8	1.36	4.9	1 stick
				18G	1.28	0.84	4.9	1 stick
				23G	0.63	0.36	4.9	1 stick
				30G	0.31	0.16	7.4	1 stick

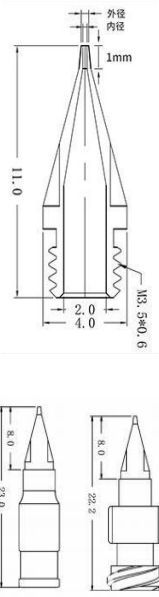

products	pictures	blueprint	material	needle length	specification	OD(A)mm	ID(B)mm	Sharpen length (C)	Needle tip OD(D)	packaging
Metal Needle Edge Grinding			needle tubing: stainless steel  pedestal: Brass (Nickel Plated)	6.5MM  13MM	18G	1.28	0.84	1.5	0.93	12PCS/bo x
					19G	1.05	0.75	1	0.84	
					20G	0.91	0.61	1	0.7	
					21G	0.81	0.51	1	0.6	
					22G	0.71	0.41	1	0.5	
					23G	0.63	0.36	1	0.45	
					24G	0.56	0.35	1	0.44	
					25G	0.51	0.27	1	0.36	
					26G	0.46	0.25	1	0.34	
					27G	0.41	0.21	1	0.29	
					28G	0.35	0.18	1	0.27	
30G	0.31	0.16	1	0.24						

products	pictures	material	needle length	OD(A)mm	ID(B)mm	total length (mm)	Ruhr OD	Ruhr ID
ASM One-Piece Dispensing Needles		stainless steel	4MM	0.50	0.25	64	7.77	4.29
				0.55	0.30			
				0.60	0.33			
				0.72	0.42			
				0.80	0.52			
				0.90	0.67			

products	pictures	blueprint	material	specification	OD(A)mm	ID(B)mm	packaging
Split precision needles			pinhead: stainless steel pedestal: stainless steel (bayonet) stainless steel (Double Threaded)	0.1	0.2	0.1	1PCS/box
				0.15	0.25	0.15	
				0.2	0.3	0.2	
				0.25	0.35	0.25	
				0.3	0.4	0.3	
				0.35	0.45	0.35	
				0.4	0.5	0.4	
				0.5	0.6	0.5	
				0.6	0.7	0.6	
				0.7	0.8	0.7	
				0.8	0.9	0.8	
				0.9	1	0.9	
				1.0	1.1	1	
				1.1	1.2	1.1	
				1.2	1.3	1.2	
				1.3	1.4	1.3	
				1.4	1.5	1.4	
				1.5	1.6	1.5	
				1.6	1.7	1.6	
				1.7	1.8	1.7	
1.8	1.9	1.8					
1.9	2	1.9					
2	2.1	2					
customizable	Customized OD	Customized ID					



products	pictures	blueprint	material	needle length	specification	OD(A)mm	ID(B)mm	length (mm)	packaging
One-piece bayonet Precision Needle			stainless steel	1MM	0.1	0.20	0.10	18.25	1pcs
					0.15	0.25	0.15		
					0.2	0.30	0.20		
					0.25	0.35	0.25		
					0.3	0.40	0.30		
					0.35	0.45	0.35		
					0.4	0.50	0.40		
					0.45	0.55	0.45		
					0.5	0.60	0.50		
					0.6	0.70	0.60		
					0.7	0.80	0.70		
					0.8	0.90	0.80		
					0.9	1.00	0.90		
					1	1.10	1.00		
					1.1	1.20	1.10		
					1.2	1.30	1.20		
					1.3	1.40	1.30		
					1.4	1.50	1.40		
					1.5	1.60	1.50		
					1.6	1.70	1.60		
					1.7	1.80	1.70		
					1.8	1.90	1.80		
					1.9	2.00	1.90		
2	2.10	2.00							
					customizable	Customized OD	ustomized I D		

products	pictures	blueprint	material	needle length	specification	OD(A)mm	ID(B)mm	length (mm)	packaging
One-piece double thread Precision needles			stainless steel	1mm	0.1	0.20	0.10	18.25	1pcs
					0.15	0.25	0.15		
					0.2	0.30	0.20		
					0.25	0.35	0.25		
					0.3	0.40	0.30		
					0.35	0.45	0.35		
					0.4	0.50	0.40		
					0.5	0.60	0.50		
					0.6	0.70	0.60		
					0.7	0.80	0.70		
					0.8	0.90	0.80		
					0.9	1.00	0.90		
					1	1.10	1.00		
					1.1	1.20	1.10		
					1.2	1.30	1.20		
					1.3	1.40	1.30		
					1.4	1.50	1.40		
					1.5	1.60	1.50		
					1.6	1.70	1.60		
					1.7	1.80	1.70		
					1.8	1.90	1.80		
					1.9	2.00	1.90		
					2	2.10	2.00		
					customizable	Customized OD	ustomized I D		



products	pictures	material	specification	ID(B)mm	total length (mm)	packaging
One-piece bayonet Extended Length Needles		stainless steel	0.20	0.20	26.4	1pcs/box
			0.25	0.25		
			0.30	0.30		
			0.35	0.35		
			0.40	0.40		
			0.50	0.50		
			0.60	0.60		
			0.70	0.70		
			0.80	0.80		
			0.90	0.90		
			1.00	1.00		
			1.10	1.10		
			1.20	1.20		
			1.30	1.30		
			1.40	1.40		
			1.50	1.50		
			1.60	1.60		
1.70	1.70					
1.80	1.80					
1.90	1.90					
2.00	2.00					

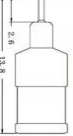

products	pictures	blueprint	material	needle length	specification	OD(A)mm	ID(B)mm	total length (mm)	packaging
One-piece metal needles			needle tubing : Brass (Nickel Plated) pedestal : Brass (Nickel Plated)	2.6	22G	0.52	0.43	13.8	12支/box
					23G	0.63	0.35		

**Customized needles of various sizes are available**

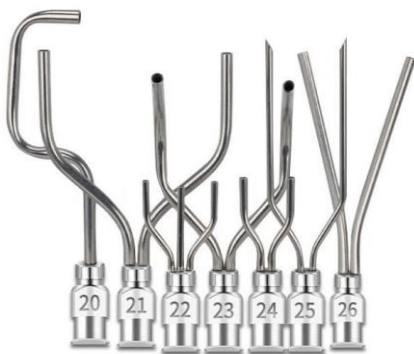

## Dispensing Valve Adapters

			
<b>KZ-JT-020</b>		<b>KZ-JT-021</b>	
Thread Specification	PT1/8-28	Thread Specification	PT1/4-19
Thread Length	8.5mm	Thread Length	10.5mm
Width	12mm	Width	14mm
Thread OD	9.5mm	Thread OD	13mm
Thread ID	6mm	Thread ID	8mm
			
			

## Tube Extension Fittings



Specification	Diameter*Tooth spacing*length
JT-024 Tube 4*2.5 Luer End	11.1*4MM*24.3
JT-025 Tube 6*4 Luer end	11.1*6MM*24.3
JT-026 Tube 8*5 Luer end	11.1*8x5MM*25.1
JT-027 Tube 8*5.5 Luer End	11.1*8x5.5MM*25.4
JT-028 Tube 10*6.5 Luer end	11.1*10MM*25.1
JT-029 Tube 4*2.5 Needle End	11.1*4MM*24.1
JT-030 Tube 6*4 Needle End	11.1*6MM*24.1
JT-031 Tube 8*5 Needle End	11.1*8x5MM*24.3
JT-032 Tube 8*5.5 Needle End	11.1*8x5.5MM*24.3
JT-033 Tube 10*6.5 Needle End	11.1*10MM*24.3



## Adaptors

<b>KZ-JT-006</b>		<b>KZ-JT-007</b>		<b>KZ-JT-008</b>		<b>KZ-JT-008</b>	
G1/8 tooth split connector		G1/4 tooth split connector		M10*1 split connector		M12*1 split connector	
Diameter	13mm	Diameter	13mm	Diameter	13mm	Diameter	13mm
Inner Diameter	5.5mm	Inner Diameter	9mm	Inner Diameter	5.5mm	Inner Diameter	9mm
Length	27.5mm	Length	27.5mm	Length	27.5mm	Length	27.5mm

<b>KZ-JT-016</b>		<b>KZ-JT-017</b>		<b>KZ-JT-018</b>		<b>KZ-JT-019</b>	
G1/8 One Piece Connector		G1/4 One Piece Connector		M10*1 One Piece Connector		M12*1 One Piece Connector	
Diameter	10mm	Diameter	13mm	Diameter	10mm	Diameter	13mm
Inner Diameter	5.5mm	Inner Diameter	9mm	Inner Diameter	5.5mm	Inner Diameter	9mm
Length	25mm	Length	23.6mm	Length	25mm	Length	25mm

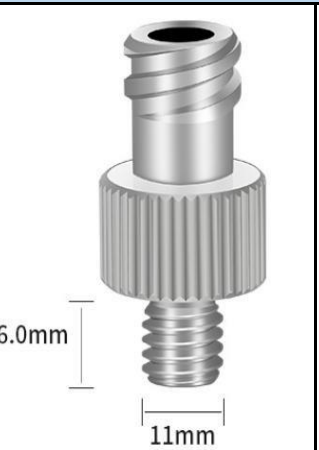
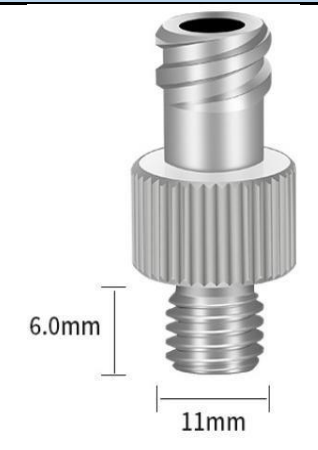
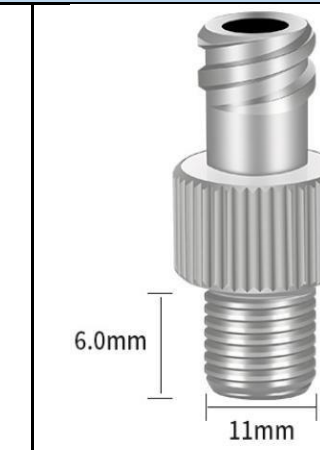
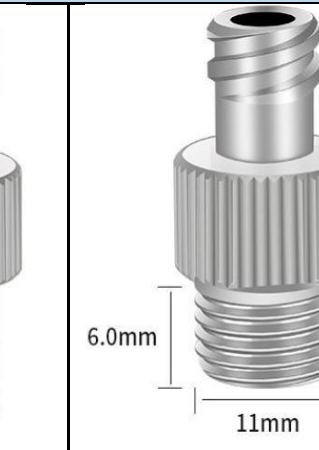

## Dispensing Adapters

							
<b>KZ-JT-010</b>	<b>KZ-JT-011</b>	<b>KZ-JT-012</b>	<b>KZ-JT-013</b>				
M5 Adapters		M6 Adapters					
M8*1 Adapters		M8*1.25 Adapters					
Thread Specification	M5*0.8	Thread Specification	M6*1.0	Thread Specification	M8*1.0	Thread Specification	M8*1.25
outer diameter	11mm	Inner Diameter	11mm	Inner Diameter	11mm	Inner Diameter	11mm
Thread length	6mm	Thread length	6mm	Thread length	6mm	Thread length	6mm

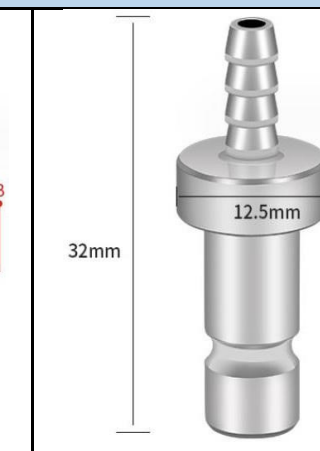
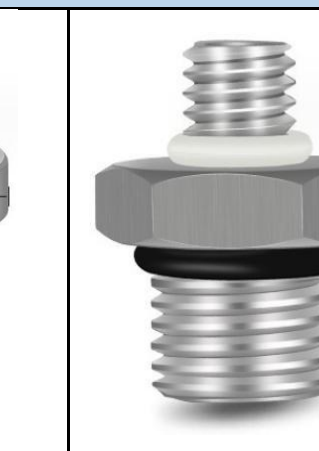

## Syringe Connection Adapter

							
<b>KZ-JT-057</b>		<b>KZ-JT-058</b>		<b>KZ-JT-075</b>		<b>KZ-JT-091</b>	
A	11mm	A	7mm				
B	7mm	B	8mm				
Thread Specification	M5*0.8	Thread Specification	8mm	Outer diameter	12.5mm	Outer diameter	18.1mm
length	24mm	length	24mm	length	32mm	length	23mm

## M Series Adapters



model number	brand name	Thread Specification	Length	OD	ID
KZ-JT-001	M4 adapters	M4*0.7	18.5	11	2.2
KZ-JT-002	M5 adapters	M5*0.8	18.5	11	2.2
KZ-JT-003	M6 adapters	M6*1.0	18.5	11	2.5
KZ-JT-004	M8*1.0 adapters	M8*1.0	18.5	11	2.5
KZ-JT-005	M8*1.25 adapters	M8*1.25	18.5	11	2.5
KZ-JT-098	M5*0.8 adapters	M5*0.8-POM	18.5	11	2.5

## Tube to Thread Adapters



model number	Tube specifications	Thread Specification	OD(A)	L(B)	L(C)	OD(D)
KZ-JT-034	4*2.5mm	PT1/8-28	3.8	6.5	8.0	11.0

KZ-JT-035	6*4.0mm	PT1/8-28	4.8	6.5	8.0	11.0
KZ-JT-089	6*4.0mm	PT1/8-28	4.8	6.5	8.0	H10
KZ-JT-036	8*5.0mm	PT1/8-28	5.9	6.5	8.0	11.0
KZ-JT-037	8*5.5mm	PT1/8-28	6.8	6.5	8.0	11.0
KZ-JT-038	10*6.5mm	PT1/8-28	7.9	6.5	8.0	11.0
KZ-JT-039	4*2.5mm	PT1/4-19	3.8	6.5	8.0	14.0
KZ-JT-040	6*4.0mm	PT1/4-19	4.8	6.5	8.0	14.0
KZ-JT-041	8*5.0mm	PT1/4-19	5.9	6.5	8.0	14.0
KZ-JT-042	8*5.5mm	PT1/4-19	6.8	6.5	8.0	14.0
KZ-JT-043	10*6.5mm	PT1/4-19	7.9	6.5	8.0	14.0
KZ-JT-044	6*4.0mm	M5*0.8	4.8	6.8	6.2	11.0
KZ-JT-045	6*4.0mm	M6*1.0	4.8	6.8	6.2	11.0
KZ-JT-046	6*4.0mm	M6*1.0	4.8	6.8	6.2	11.0
KZ-JT-047	6*4.0mm	M8*1.25	4.8	6.8	6.2	11.0
KZ-JT-094	4*2.5mm	M6*1.0	4.8	6.8	8.0	8.0